

Standard Triac

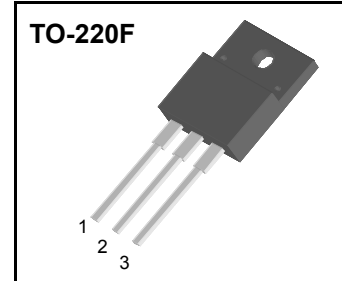
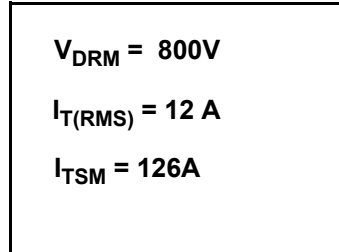
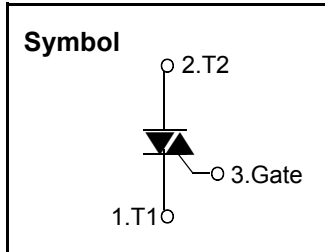

Features

- ◆ Repetitive Peak Off-State Voltage : 800V
- ◆ R.M.S On-State Current ($I_{T(RMS)} = 1 A$)
- ◆ High Commutation dv/dt

General Description

This device is suitable for low power AC switching application, phase control application such as fan speed and temperature modulation control, lighting control and static switching relay where high sensitivity is required in all four quadrants.

Absolute Maximum Ratings ($T_j = 25^\circ C$ unless otherwise specified)

Symbol	Parameter	Condition	Ratings	Units
V_{DRM}	Repetitive Peak Off-State Voltage	Sine wave, 50 to 60 Hz	800	V
$I_{T(RMS)}$	R.M.S On-State Current	$T_j = 125^\circ C$, Full Sine wave	12	A
I_{TSM}	Surge On-State Current	One Cycle, 50Hz/60Hz, Peak, Non-Repetitive	120/126	A
I^2t	I^2t	$t_p = 10ms$	72	A ² s
$P_{G(AV)}$	Average Gate Power Dissipation	$T_j = 125^\circ C$	1	W
I_{GM}	Peak Gate Current	$T_j = 125^\circ C$	2	A
T_j	Operating Junction Temperature		- 40 ~ 125	$^\circ C$
T_{STG}	Storage Temperature		- 40 ~ 150	$^\circ C$



TF12A80

Electrical Characteristics (T_j=25 °C unless otherwise specified)

Symbol	Items		Conditions	Ratings			Unit
				Min.	Typ.	Max.	
I _{DRM}	Repetitive Peak Off-State Current		V _D = V _{DRM} , Single Phase, Half Wave T _j = 125 °C	---	---	2.0	mA
V _{TM}	Peak On-State Voltage		I _{TM} = 17 A, t _p =380μs	---	---	1.55	V
I ⁺ _{GT1}	I	Gate Trigger Current	V _D = 12V, R _L =30 Ω	—	—	30	mA
I ⁻ _{GT1}	II			—	—	30	
I ⁻ _{GT3}	III			—	—	30	
V ⁺ _{GT1}	I	Gate Trigger Voltage	V _D = 12 V, R _L =30 Ω	—	—	1.5	V
V _{GT1}	II			—	—	1.5	
V _{GT3}	III			—	—	1.5	
V _{GD}	Non-Trigger Gate Voltage		T _J = 125 °C, V _D = V _{DRM} R _L =3.3kΩ	0.2	—	-	V
dv/dt	Critical Rate of Rise Off-State Voltage		T _J = 125 °C V _D =2/3 V _{DRM}	200	—	—	V/μs
I _H	Holding Current		I _T =0.2A	—	--	50	mA



Fig 1. Gate Characteristics

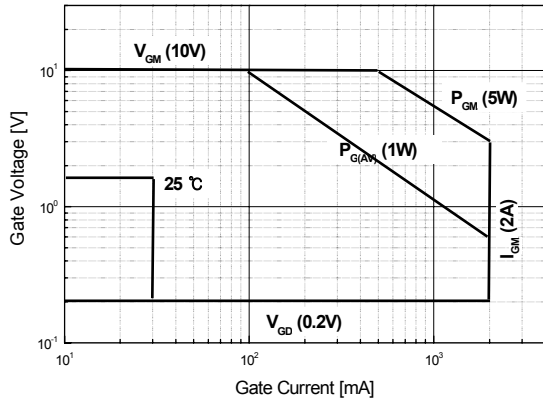

Fig 2. On-State Voltage

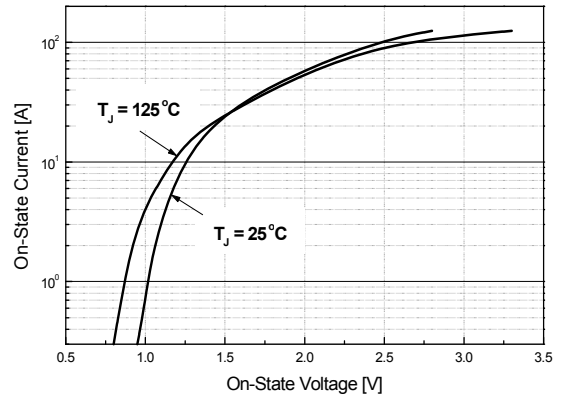

Fig 3. On State Current vs. Maximum Power Dissipation

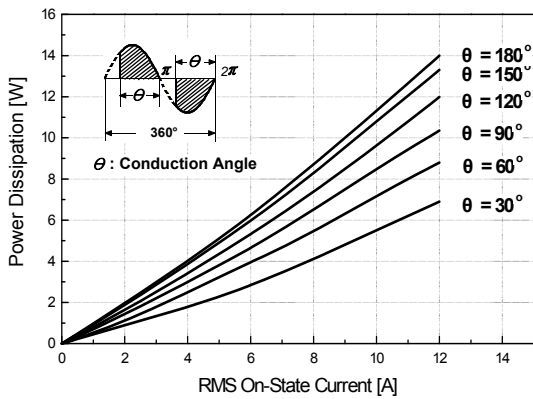

Fig 4. On State Current vs. Allowable Case Temperature

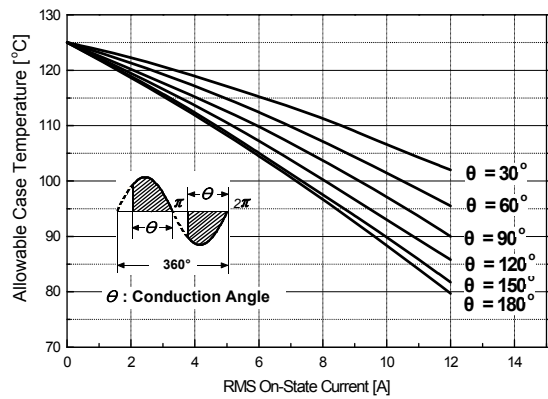

Fig 5. Surge On-State Current Rating (Non-Repetitive)

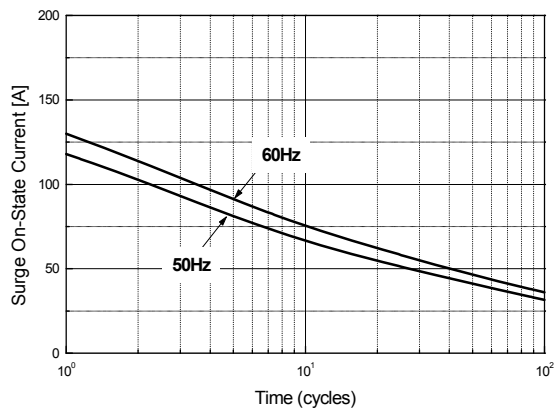

Fig 6. Gate Trigger Voltage vs. Junction Temperature

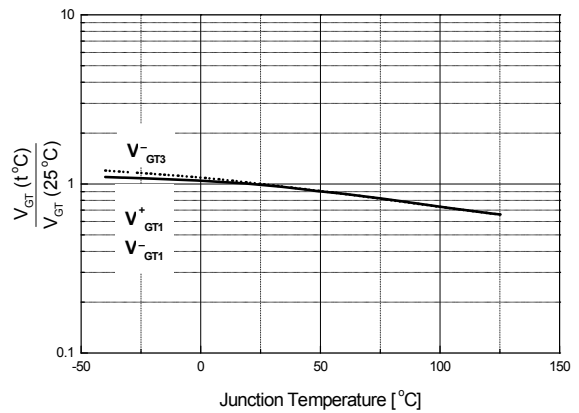



Fig 7. Gate Trigger Current vs. Junction Temperature

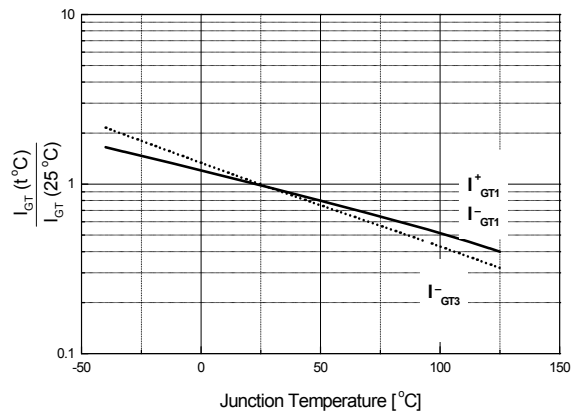
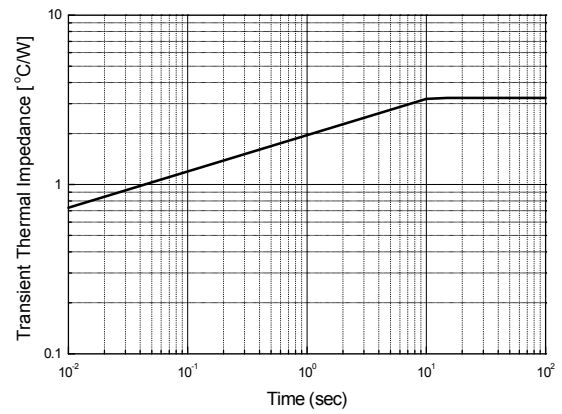

Fig 8. Transient Thermal Impedance





TF12A80

TO-220F Package Dimension

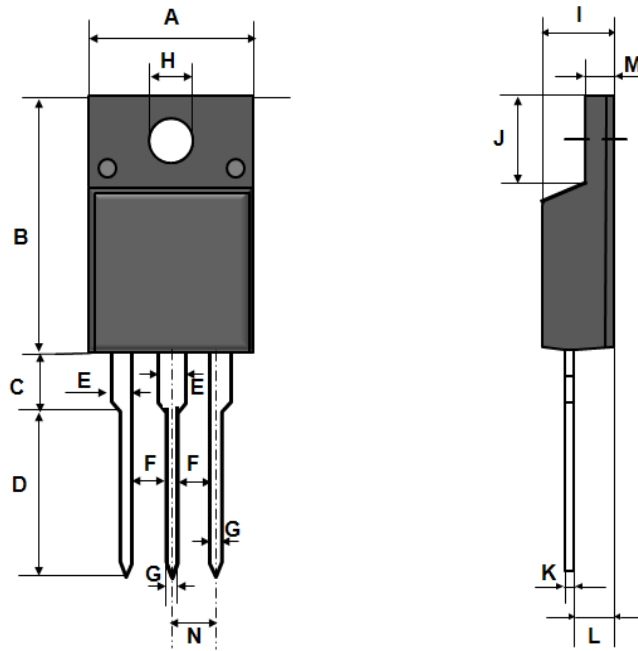

Symbol	INCHES			MILLIMETERS		
	MIN	TYP	MAX		MIN	TYP
A	9.88	10.08	10.28	25.10	25.60	26.11
B	15.30	15.50	15.70	38.86	39.37	39.88
C	2.95	3.00	3.05	7.49	7.62	7.75
D	10.30	10.50	10.70	26.16	26.67	27.18
E	0.95	1.08	1.20	2.41	2.74	3.05
F	1.81	1.84	1.87	4.60	4.67	4.75
G	0.50	0.70	0.90	1.27	1.78	2.29
H	3.00	3.20	3.40	7.62	8.13	8.64
I	4.35	4.45	4.55	11.05	11.30	11.56
J	6.20	6.40	6.60	15.75	16.26	16.76
K	0.41	0.51	0.61	1.03	1.28	1.54
L	2.30	2.50	2.70	5.84	6.35	6.86
M	2.53	2.73	2.93	6.43	6.93	7.44
N	2.34	2.54	2.74	5.94	6.45	6.96



TO-220F Package Dimension, Forming

Dim.	mm			Inch		
	Min.	Typ.	Max.	Min.	Typ.	Max.
A	10.4		10.6	0.409		0.417
B	6.18		6.44	0.243		0.254
C	9.55		9.81	0.376		0.386
D	8.4		8.66	0.331		0.341
E	6.05		6.15	0.238		0.242
F	1.26		1.36	0.050		0.054
G	3.17		3.43	0.125		0.135
H	1.87		2.13	0.074		0.084
I	2.57		2.83	0.101		0.111
J		2.54			0.100	
K		5.08			0.200	
L	2.51		2.62	0.099		0.103
M	1.23		1.36	0.048		0.054
N	0.45		0.63	0.018		0.025
O	0.65		0.78	0.0025		0.031
P		5.0			0.197	
ϕ		3.7			0.146	
$\phi 1$		3.2			0.126	
$\phi 2$		1.5			0.059	

